

Catálogo 2024 Exterior

**Inspiring
Aesthetic**
with
**Functional
Brilliance**

**04 Uplights
empotrables**
(07): Visor

**10 Downlights
empotrables**
(11): Vali IP54
(19) Glow 4W IP67

**22 Apliques
de pared**
(23): Walter
(27): Flauta

**32 Proyectores de
superficie y piqueta**
(33): Maya IP67
(39): Maui
(43): Eyelet
(47): Kano
(51): Momo

**54 Balizas
y bolardos**
(55): Dit
(59): Versat C
(63): Versat R
(67): Verso
(71): Abyss

**74 Wallwasher
de superficie**
(75): Bent

Uplights empotrables

(04)

exlux (exterior) uplights empotrables

Visor

Uplight apto para su uso en exteriores con protección IP67, disponible en potencias de 2W, 4W y 6W, con ángulos de apertura de 15° y 30° y equipado con accesorio anti deslumbramiento



(06)

Material

Aluminio anodizado 5051

Acabados



Montaje



Temperatura de color



Protección / CRI / Certificados



Visor 2w

(07)



Dimensiones

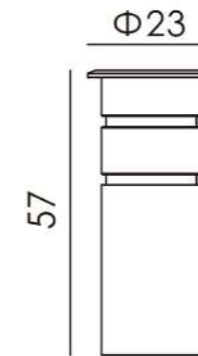

Medidas corte

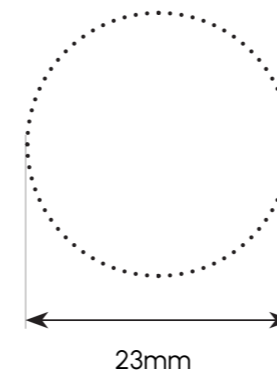

Parámetros	
Potencia	2W
Ángulo de apertura	15°
Voltaje de entrada	DC 24V
Flujo luminoso	80lm
Temperatura operativa	-25°C +40°C

Luxometría

Ángulo de apertura 15°

altura media/centro	diámetro
1m 2475 lx	18 cm
2m 619 lx	36 cm
3m 275 lx	54 cm



Fotometría

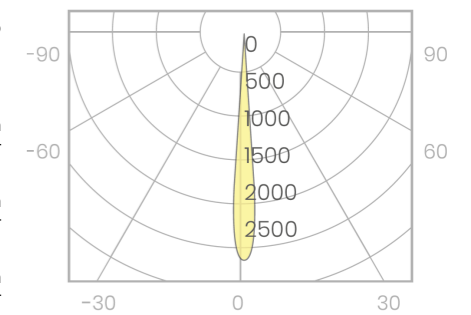

Referencias

VISOR 2W

Acero inoxidable			
2700K	15°	Dimable	55801

Visor 4w

(08)



Dimensiones

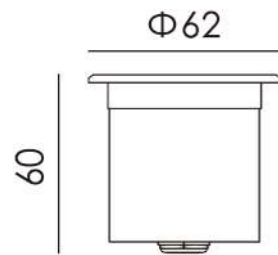

Parámetros

Potencia	4W
Ángulo de apertura	15° / 30°
Voltaje de entrada	DC 24V
Flujo luminoso	210lm
Temperatura operativa	-25°C +40°C

Medidas corte

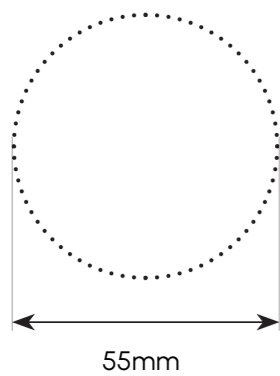

Luxometría

Ángulo de apertura 30°

altura media/centro	diámetro
1m 524 lx	54 cm
2m 131 lx	108 cm
3m 58 lx	162 cm

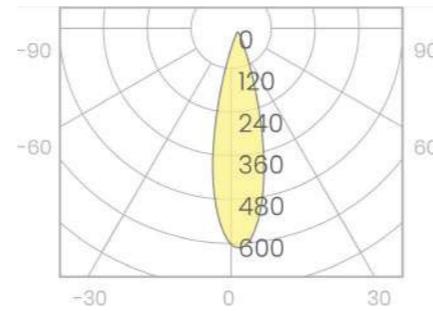
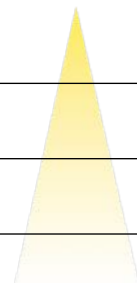

Fotometría

Dimensiones

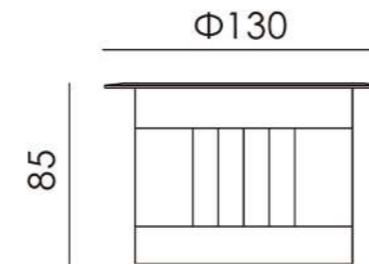

Parámetros

Potencia	6W
Ángulo de apertura	15° / 30°
Voltaje de entrada	DC 24V
Flujo luminoso	420lm
Temperatura operativa	-25°C +40°C

Medidas corte

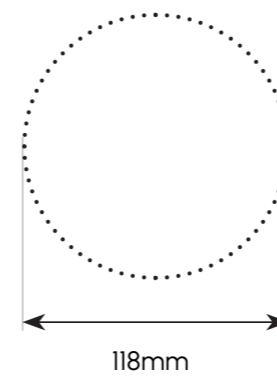

Luxometría

Ángulo de apertura 30°

altura media/centro	diámetro
1m 837 lx	54 cm
2m 209 lx	108 cm
3m 93 lx	162 cm

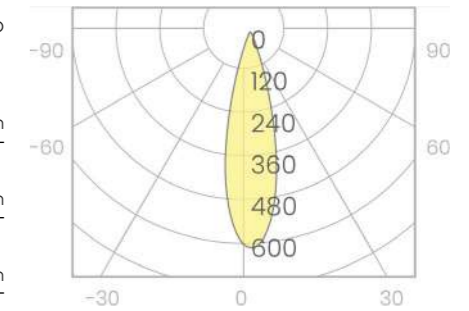
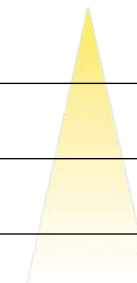

Fotometría

Referencias

VISOR 4W

Acero inoxidable			
2700K	15°	Dimable	54774
	30°	Dimable	46250

Visor 6w

(09)



Dimensiones

Parámetros

Potencia	6W
Ángulo de apertura	15° / 30°
Voltaje de entrada	DC 24V
Flujo luminoso	420lm
Temperatura operativa	-25°C +40°C

Medidas corte

Luxometría

Ángulo de apertura 30°

altura media/centro	diámetro
1m 837 lx	54 cm
2m 209 lx	108 cm
3m 93 lx	162 cm

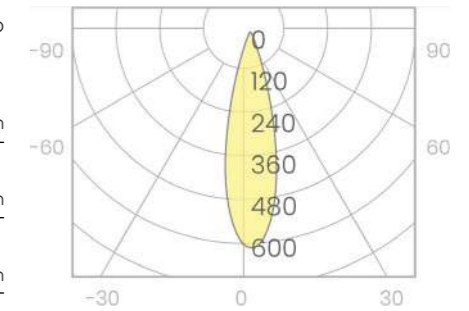
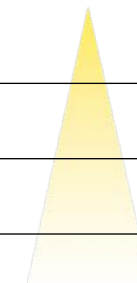

Fotometría

Referencias

VISOR 6W

Acero inoxidable			
2700K	15°	Dimable	55825
	30°	Dimable	55832

Downlights empotrables

(10)

exlux (exterior) downlights y spotlights empotrables

Voli IP54 6W

Mini downlight empotrable de solamente 3 cm de diámetro.

Sus reducidas dimensiones lo convierten en un producto elegante a la par que discreto para aportar una iluminación de acento que dará más protagonismo a la luz en sí que al objeto que la emite.

Disponibile con ángulo de apertura de 10 grados y en acabado blanco, negro o mixto.

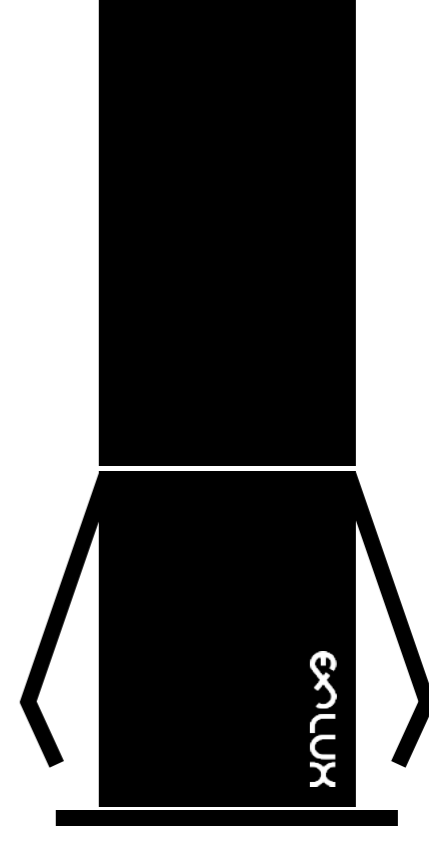

(12)

Material

Aluminio anodizado 5051

Acabados

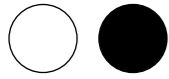

Montaje



Temperatura de color



Protección / CRI / Certificados

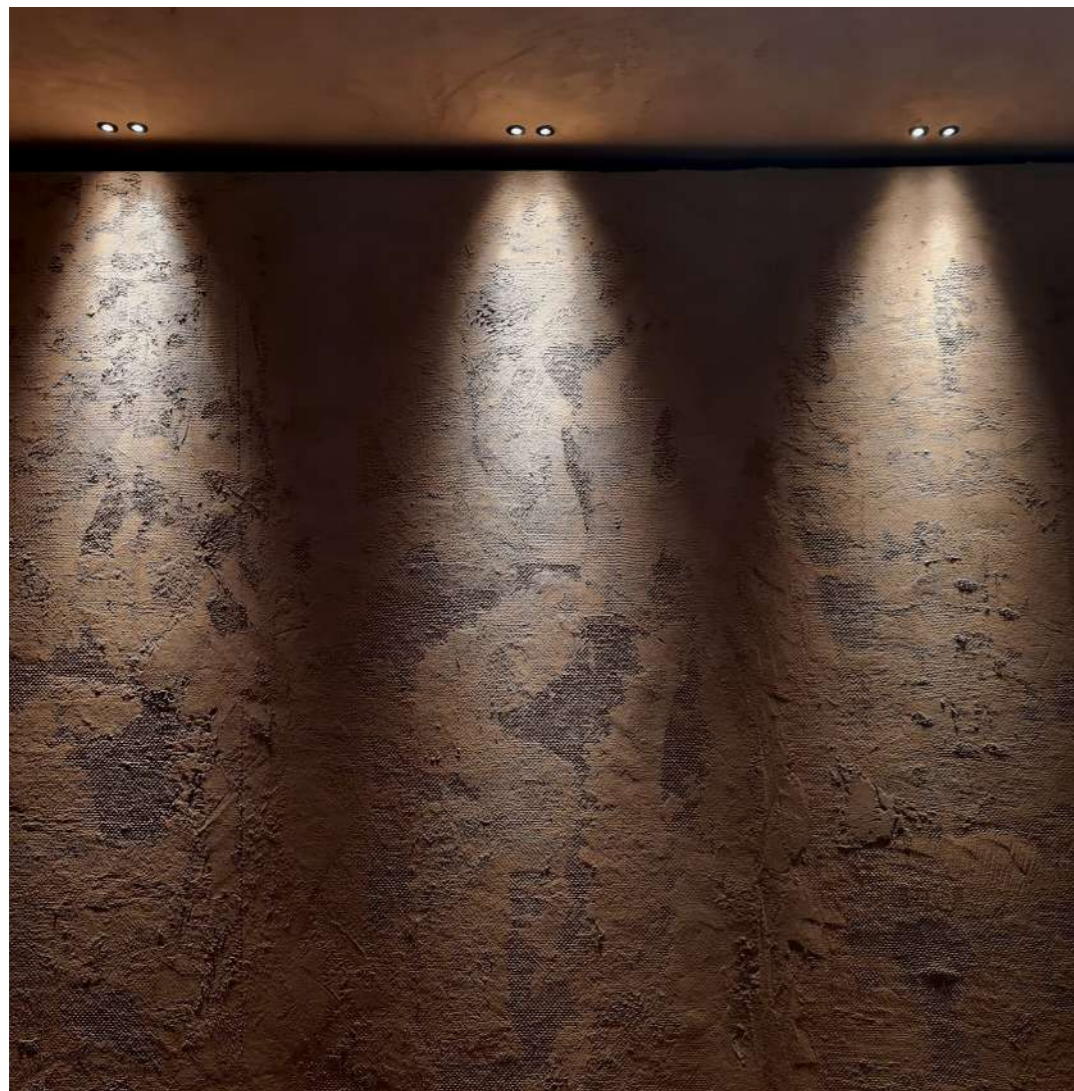

(13)



Dimensiones

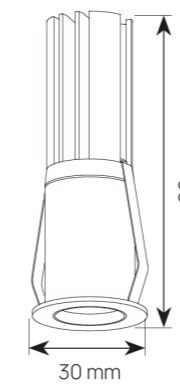

Medidas corte

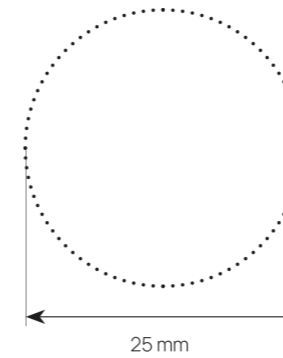

Parámetros

Potencia	6W
Temperatura de color	2300K / 2700K
Ángulo de apertura	10°
Voltaje de entrada	AC 220-240V
Corriente de salida	1350mA
Tensión de funcionamiento	3V
Flujo luminoso	360lm
Temperatura operativa	-25°C +40°C

Luxometría

Ángulo de apertura 10°

	altura media/centro	diámetro
1m	3184lx	20cm
2m	796lx	42cm
3m	360lx	63cm

Fotometría

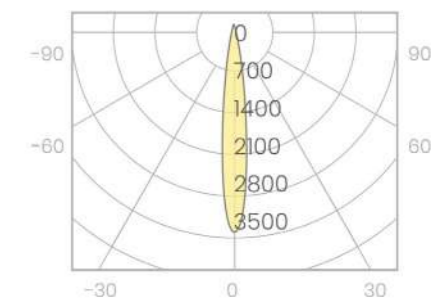

Referencias

Blanco			
2300K	10°	On/off	57157
2300K	10°	Sin Electrónica	57171
2700K	10°	On/off	55351
2700K	10°	Sin Electrónica	57164
Negro			
2300K	10°	On/off	57188
2300K	10°	Sin Electrónica	57201
2700K	10°	On/off	55368
2700K	10°	Sin Electrónica	57195

exlux (exterior) downlights y spotlights empotrables

Voli IP54 9W

Mini downlight empotrable de 56 mm de diámetro.

Sus reducidas dimensiones lo convierten en un producto elegante a la par que discreto para aportar una iluminación de acento que dará más protagonismo a la luz en sí que al objeto que la emite.

Disponible con ángulo de apertura de 15 grados y en acabado blanco, negro o mixto.

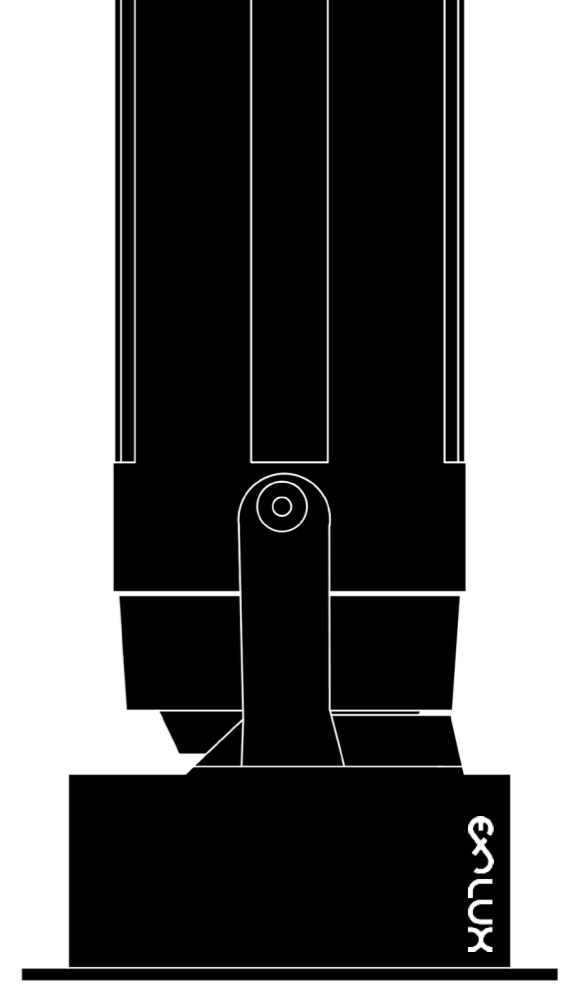

(16)

Material

Aluminio anodizado 5051

Acabados

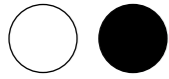

Montaje



Temperatura de color



Protección / CRI / Certificados



Vali 9w

(17)



Dimensiones

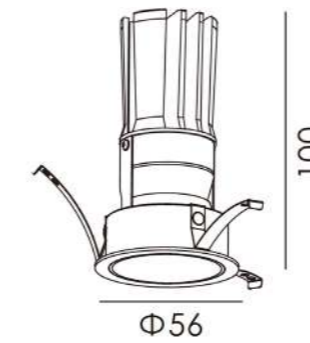

Medidas corte

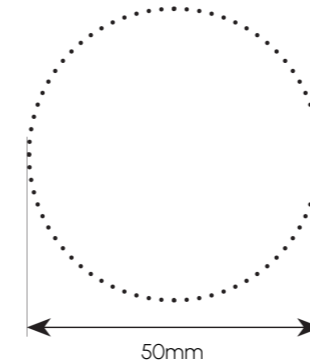

Parámetros

Potencia	9W
Temperatura de color	2300K / 2700K
Ángulo de apertura	15°
Voltaje de entrada	AC 220-240V
Corriente de salida	200mA
Tensión de funcionamiento	36V
Flujo luminoso	540lm
Temperatura operativa	-25°C +40°C

Luxometría

Ángulo de apertura 15°

altura media/centro	diámetro
1m 2875lx	33cm
2m 718lx	66cm
3m 320lx	100cm

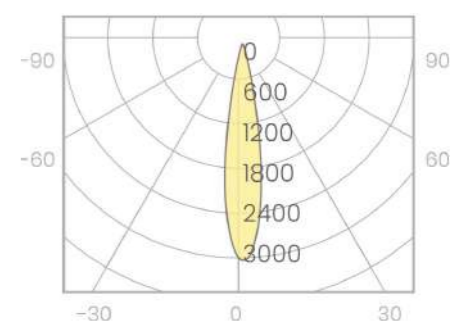

Fotometría

Referencias

Blanco			
2300K	10°	Triac	57300
2300K	10°	Sin Electrónica	57324
2700K	10°	Triac	57294
2700K	10°	Sin Electrónica	57317
Negro			
2300K	10°	Triac	57348
2300K	10°	Sin Electrónica	57362
2700K	10°	Triac	57331
2700K	10°	Sin Electrónica	57355

EXLUX (exterior) downlights y spotlights empotrables

GLOW IP65

Downlight lineal compuesto por pequeños módulos de alta potencia que nos permite alcanzar un efecto minimalista y limpio.

Su UGR inferior a 13, gracias a su reflector, consigue que sea casi imperceptible que esté encendido y no deslumbre nada.

Disponible con ángulo de apertura de 45 grados y en acabado blanco, negro o mixto.

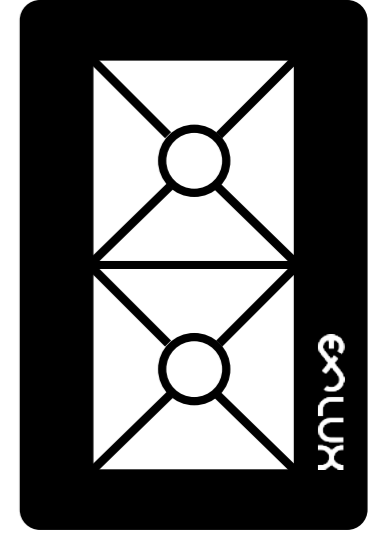

(20)

Material

Aluminio anodizado 5051

Acabados

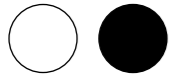

Montaje



Temperatura de color

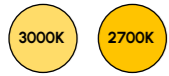

Protección / CRI / Certificados



Glow IP65 4w

(21)



Dimensiones

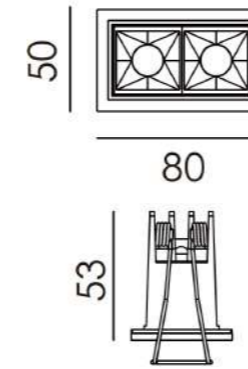

Medidas corte

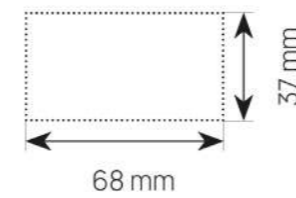

Parámetros

Potencia	4W
Ángulo de apertura	15° / 45°
Chip LED	Osram
Voltaje de entrada	AC 220-240V
Corriente de salida	700mA
Tensión de funcionamiento	2,5 - 7V
Flujo luminoso	280lm
Óptica	PMMA
Temperatura operativa	-25°C +40°C

Luxometría

Ángulo de apertura 45°

altura media/centro	diámetro
1m 387/564 lx	85 cm
2m 97/141 lx	160 cm
3m 46/63 lx	253 cm

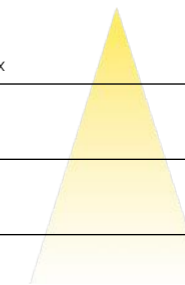

Fotometría

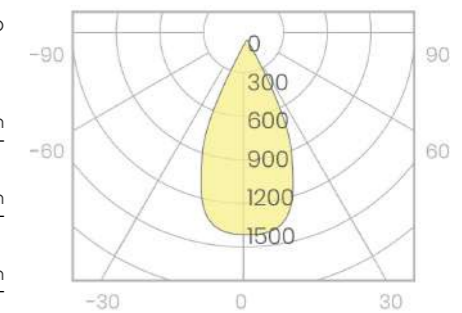

Referencias

Blanco			
2700K	45°	Triac	34738
	45°	Sin Electrónica	34745
Negro			
2700K	45°	Triac	34752
	45°	Sin Electrónica	34769

Apliques de pared

(22)

enluxe (exterior) apliques de pared

Walter

Aplique de exterior en forma de cilindro de 40 mm de diámetro y 400 mm de longitud con una fuente de luz de 5W de potencia en cada extremo.

Disponible con ángulos de apertura de 24° y en acabados blanco y negro.

enluxe

(24)

Material

Aluminio anodizado 5051

Acabados

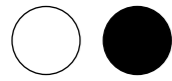

Montaje



Temperatura de color



Protección / CRI / Certificados



Walter 2x5w

(25)

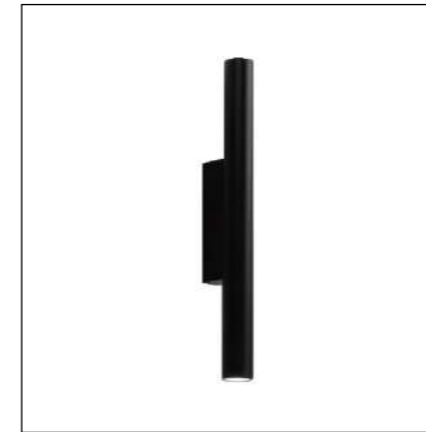

Dimensiones

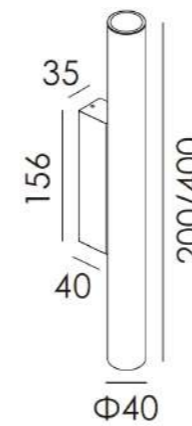

Parámetros

Potencia	2x5W
Ángulo de apertura	24°
Voltaje de entrada	AC 220-240V
Corriente de salida	150mA
Tensión de funcionamiento	36V
Flujo luminoso	2x350lm
Temperatura operativa	-25°C +40°C

Referencias

Blanco			
2700K	24°	On/off	52039
Negro			
2700K	24°	On/off	52046

EXLUX (exterior) apliques de pared

Faluto

Aplique de exterior en forma de cilindro de 65 mm de diámetro y altura de 140 mm con fuente de luz en un extremo o 180 mm con fuente de luz en ambos extremos.

Disponibile con ángulos de apertura de 24° y en acabados blanco y negro.



(28)

Material

Aluminio anodizado 5051

Acabados

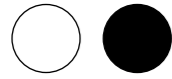

Montaje



Temperatura de color



Protección / CRI / Certificados



Flauta 7w

(29)



Dimensiones

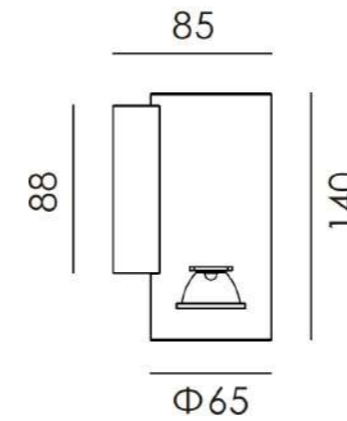

Parámetros

Potencia	7W
Ángulo de apertura	24°
Voltaje de entrada	AC 220-240V
Corriente de salida	150mA
Tensión de funcionamiento	36V
Flujo luminoso	490lm
Temperatura operativa	-25°C +40°C

Luxometría

Ángulo de apertura 24°

altura media/centro	diámetro
1m 2678 lx	42 cm
2m 669 lx	84 cm
3m 298 lx	126 cm

Fotometría

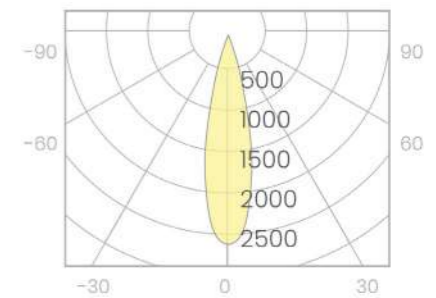

Referencias

Blanco			
2700K	24°	Triac	55788
Negro			
2700K	24°	Triac	55771

Flauta 2x7w

(30)

(31)

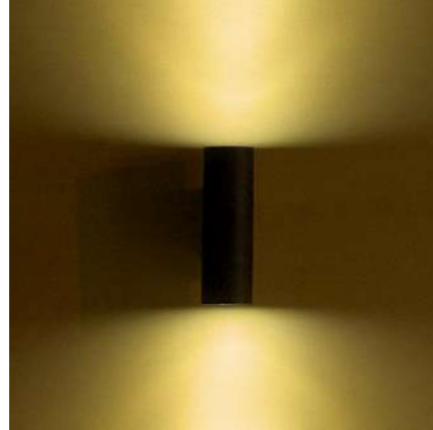

Dimensiones

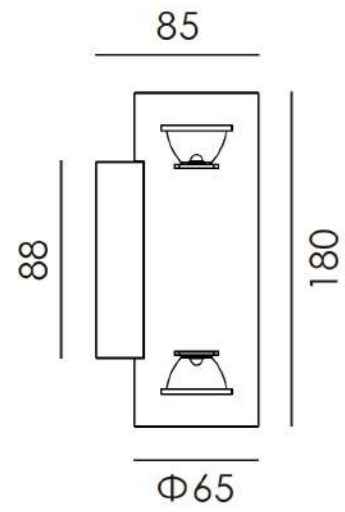

Parámetros

Potencia	2x7W
Ángulo de apertura	24°
Voltaje de entrada	AC 220-240V
Corriente de salida	150mA
Tensión de funcionamiento	36V
Flujo luminoso	2x490lm
Temperatura operativa	-25°C +40°C

Luxometría

Ángulo de apertura 24°

altura media/centro	diámetro
1m 2678 lx	42 cm
2m 669 lx	84 cm
3m 298 lx	126 cm

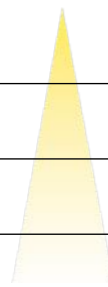

Fotometría

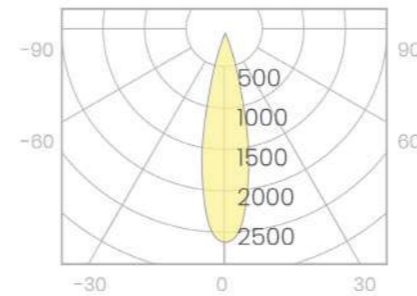

Referencias

Blanco			
2700K	24°	Triac	55764
Negro			
2700K	24°	Triac	55757

Proyectores de superficie y piqueta

(32)

enluxe (exterior) proyectores de superficie o piqueta

Maya

Pequeño proyector cilíndrico orientable con 3W de potencia. Equipado con tecnología focusable que permite variar su ángulo de apertura de 9° a 25°.

Disponibile en acabados blanco y negro.

Sus reducidas dimensiones lo convierten en el elemento ideal para crear una iluminación de acento discreta y efectiva.

Adicionalmente se le puede modificar la longitud de la "tija" para aplicaciones en las que se requiera que la fuente de luz esté más separada de la base.

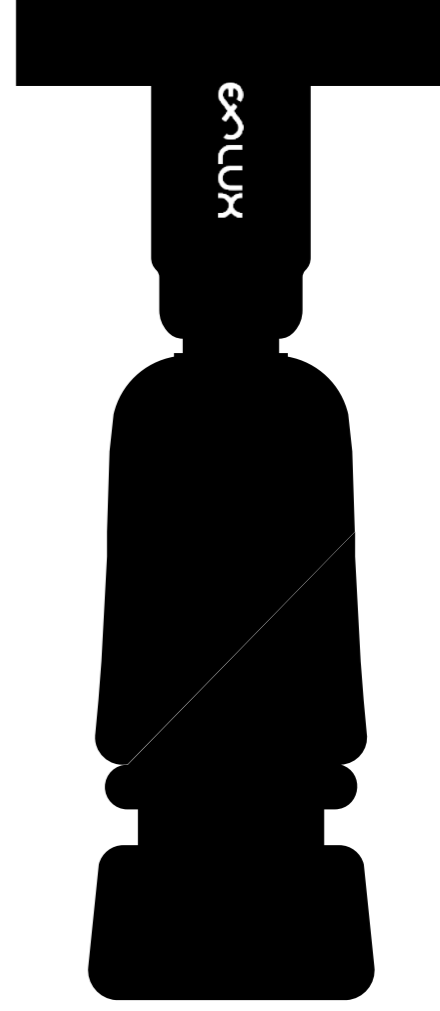

(34)

Material

Aluminio anodizado 5051

Acabados

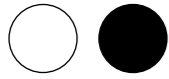

Montaje

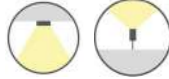

Temperatura de color



Protección / CRI / Certificados



Dimensiones

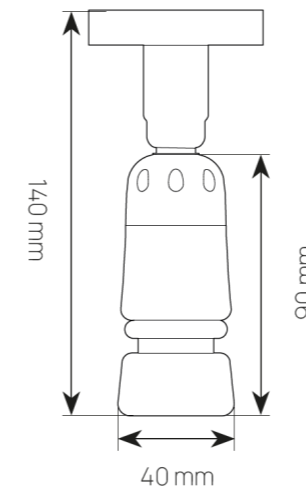

(35)



Parámetros

Potencia	3W
Temperatura de color	2300K / 2700K
CRI	80 / 90
Chip LED	Osram
Ángulo de apertura	15°-48° focusable
Voltaje de entrada	AC220-240V 50-60Hz
Corriente de salida	700mA
Tensión de funcionamiento	3V
Flujo luminoso	90lm
Óptica	PMMA
Rotación	360° (x) 90° (y)
Temperatura operativa	-25°C +40°C

Luxometría

Ángulo de apertura 15°

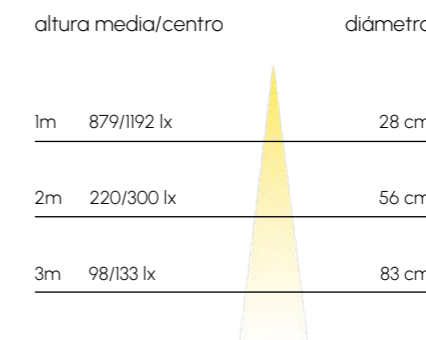

Ángulo de apertura 48°

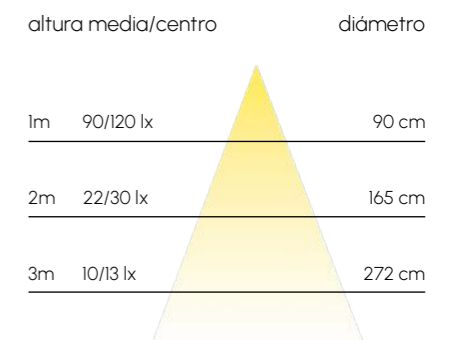

Fotometría

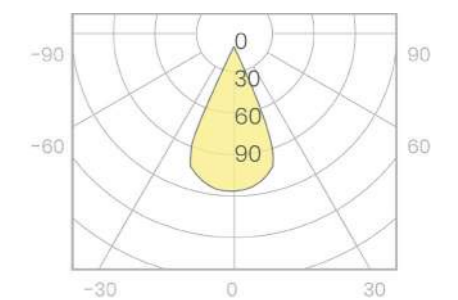
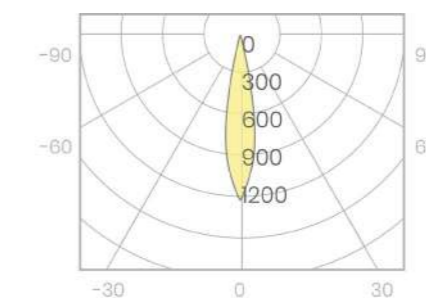



(36)

(37)

Dimensiones

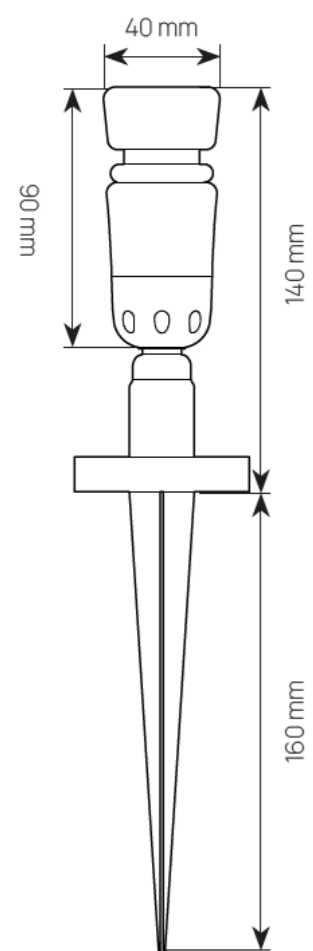

Parámetros

Potencia	3W
Temperatura de color	2300K / 2700K
CRI	80 / 90
Chip LED	Osram
Ángulo de apertura	15°-48° focusable
Voltaje de entrada	AC220-240V 50-60Hz
Corriente de salida	700mA
Tensión de funcionamiento	3V
Flujo luminoso	90lm
Óptica	PMMA
Rotación	360° (x) 90° (y)
Temperatura operativa	-25°C +40°C

Luxometría

Ángulo de apertura 15°

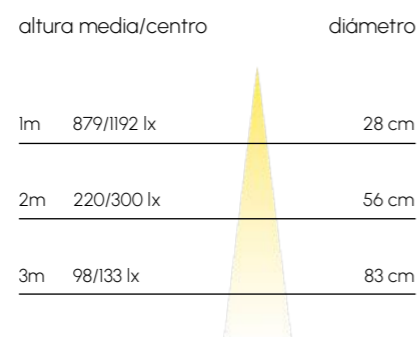

Ángulo de apertura 48°

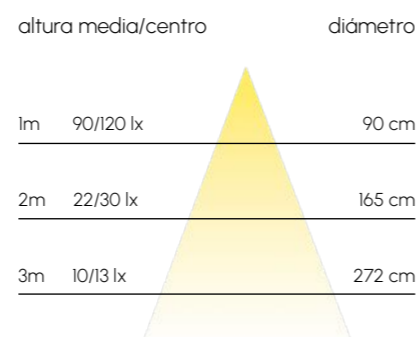

Fotometría

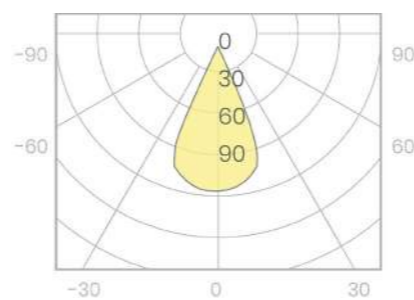
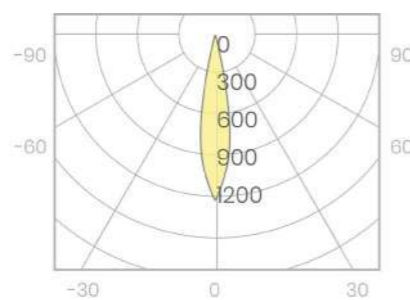

Referencias

MAYA IP67 3W

Blanco			
2300K	15° a 48°	On/off	33595
	15° a 48°	Sin Electronica	38552
2700K	15° a 48°	On/off	38446
	15° a 48°	Sin Electrónica	38569
Negro			
2300K	15° a 48°	On/off	34059
	15° a 48°	Sin Electrónica	38699
2700K	15° a 48°	On/off	38682
	15° a 48°	Sin Electrónica	38736

MAYA IP67 PIQUETA 3W

Blanco			
2300K	15° to 48°	On/off	16758
	15° to 48°	Sin Electrónica	38385
2700K	15° to 48°	On/off	34066
	15° to 48°	Sin Electrónica	38392
Negro			
2300K	15° to 48°	On/off	10725
	15° to 48°	Sin Electrónica	38620
2700K	15° to 48°	On/off	38613
	15° to 48°	Sin Electrónica	38637

EXLUX (exterior) proyectores de superficie o piqueta

Maui

Maui es un potente proyector de exterior con 9W de potencia y ópticas de 15° o 45°.

Está disponible para instalación en superficie o en piqueta.

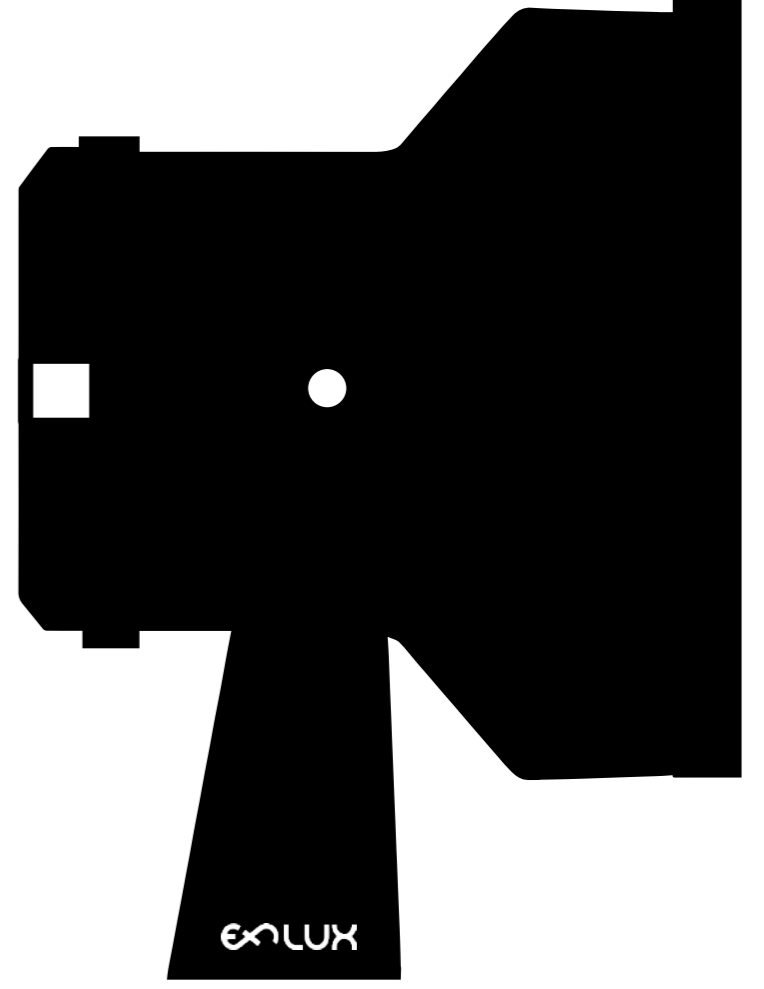

(40)

Material

Aluminio anodizado 5051

Acabados



Montaje



Temperatura de color



Protección / CRI / Certificados

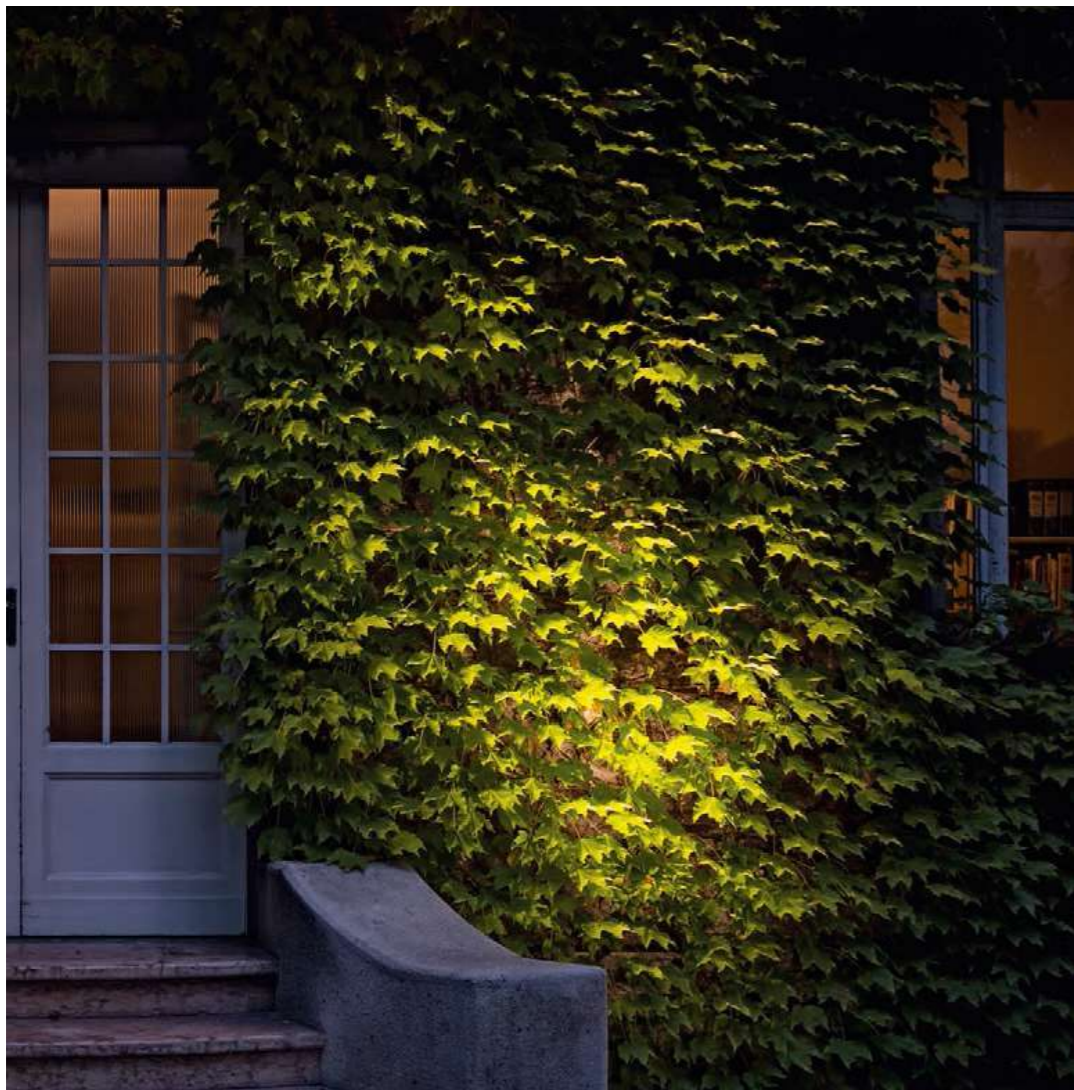

(41)



Dimensiones

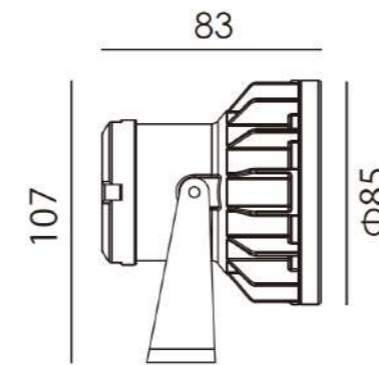

Accesorios



Parámetros

Potencia	9W
Temperatura de color	2700K
CRI	90
Ángulo de apertura	15° / 45°
Voltaje de entrada	DC24V
Flujo luminoso	600lm
Temperatura operativa	-25°C +40°C

Referencias

MAUI 9W

Antracite Grey			
2700K	15°	Dimm	59922
	45°	Dimm	59939
Accesorio piqueta			59946

EXLUX (exterior) proyectores de superficie o piqueta

Eyelet

Mini proyector de exterior focusable 15-24° con potencia de 3W.

Disponible para instalación en superficie o en piqueta.

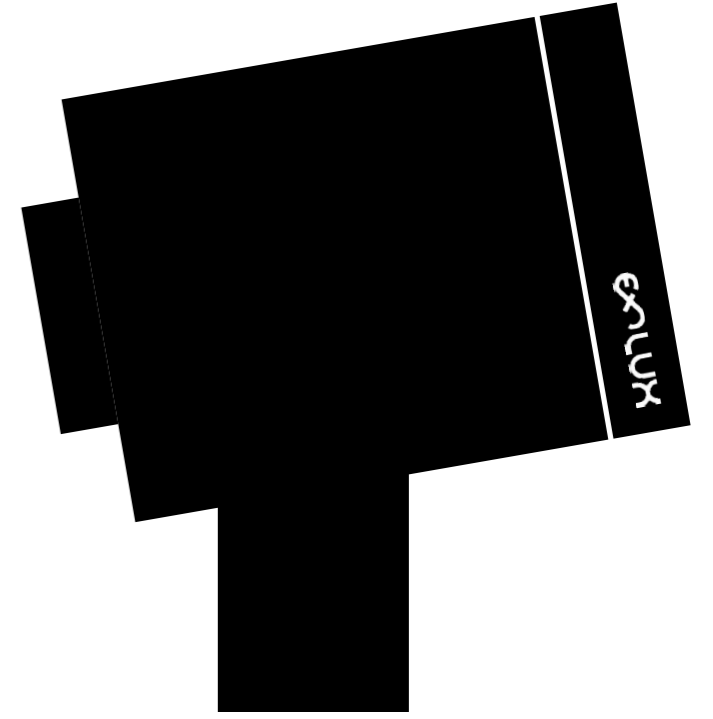

(44)

Material

Aluminio anodizado 5051

Acabados



Montaje



Temperatura de color



Protección / CRI / Certificados



Dimensiones

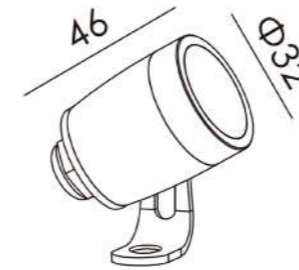

(45)



Parámetros

Potencia	3W
Temperatura de color	2700K
CRI	90
Ángulo de apertura	15° / 24°
Voltaje de entrada	AC220-240V 50-60Hz
Corriente de salida	700mA
Tensión de funcionamiento	4V
Flujo luminoso	198lm
Temperatura operativa	-25°C +40°C

Referencias

EYELET IP65 3W

Negro			
2700K	15°	On/Off	53395
	15°	Sin Electrónica	53418
	24°	On/Off	53425
	24°	Sin Electrónica	53449
Accesorio piqueta			60331

EXLUX (exterior) proyectores de superficie o piqueta

Kaino

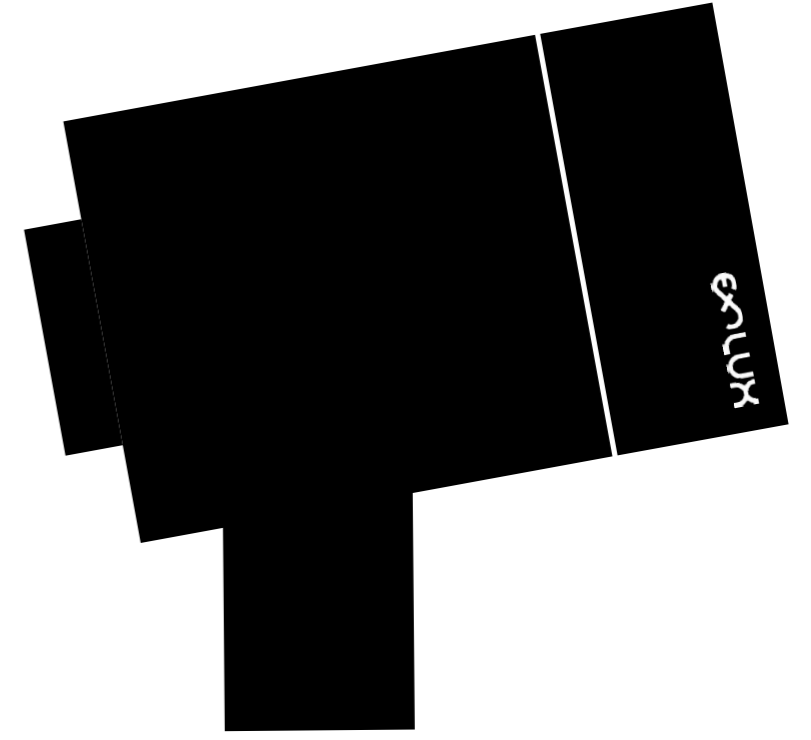

Proyector de exterior con potencia de 5W.
Disponible para instalación en superficie o en piqueta,
con ópticas de 15°, 24° y 36°.

(48)

Material

Aluminio anodizado 5051

Acabados



Montaje



Temperatura de color



Protección / CRI / Certificados

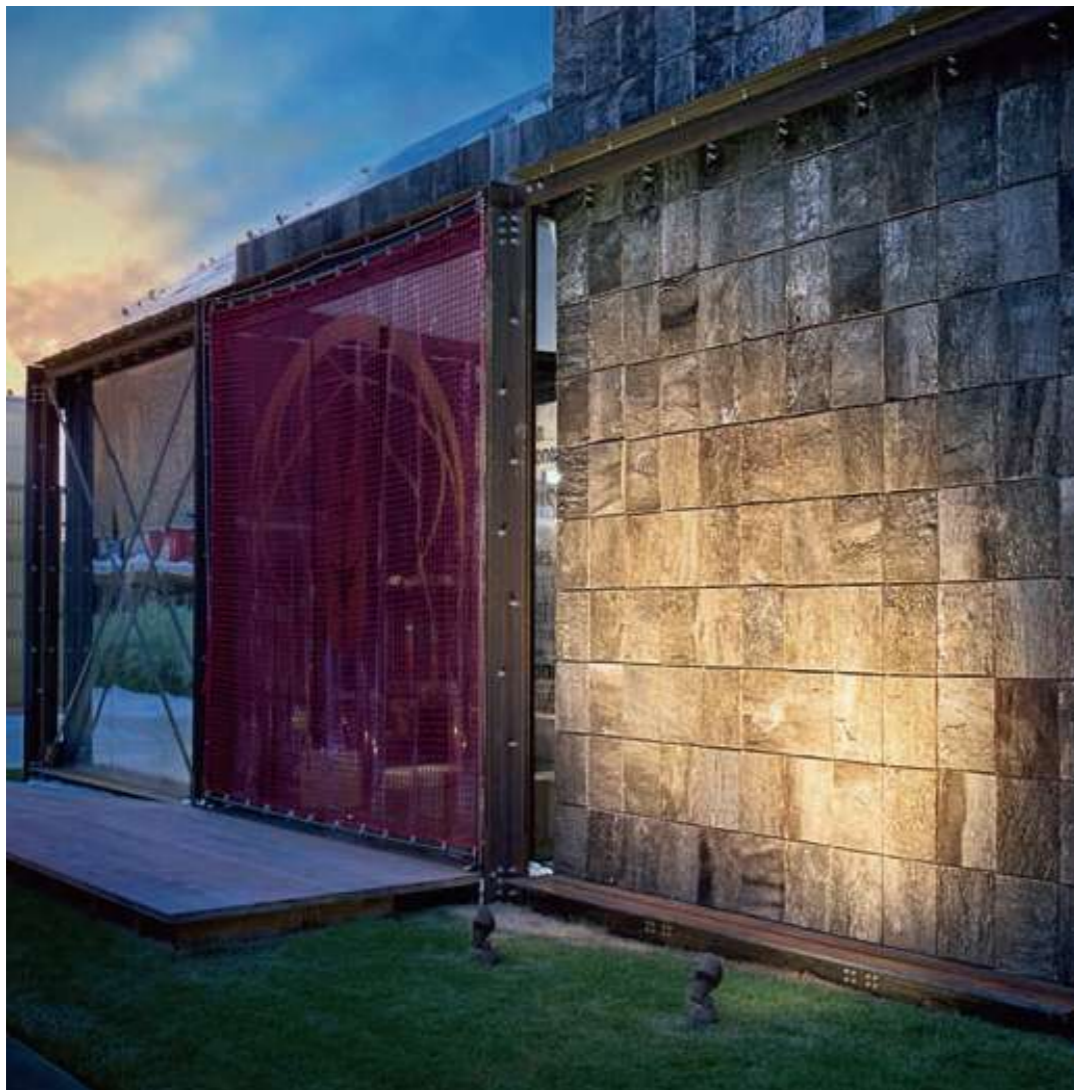

(49)

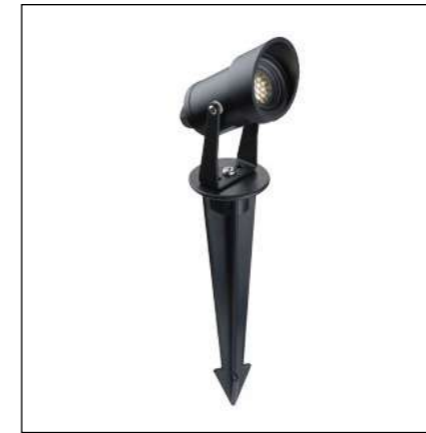

Dimensiones

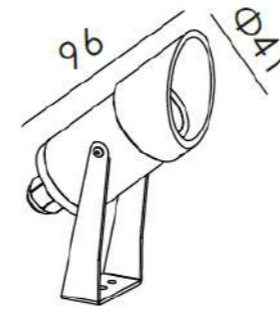

Parámetros

Potencia	5W
Temperatura de color	2700K
CRI	90
Ángulo de apertura	15° / 24° / 36°
Voltaje de entrada	24V
Flujo luminoso	300lm
Temperatura operativa	-25°C +40°C

Referencias

KANO IP65 5W

Antracite Grey			
2700K	15°	Triac	55733
	15°	On/off	52121
	36°	Triac	55740
	36°	On/off	52183
Accesorio piqueta			60348

EXLUX (exterior) proyectores de superficie o piqueta

Momo

Mini proyector de exterior de 3W de potencia y 15° de apertura, agrupable en 1, 2 o 3 unidades en una misma piqueta cilíndrica esbelta.

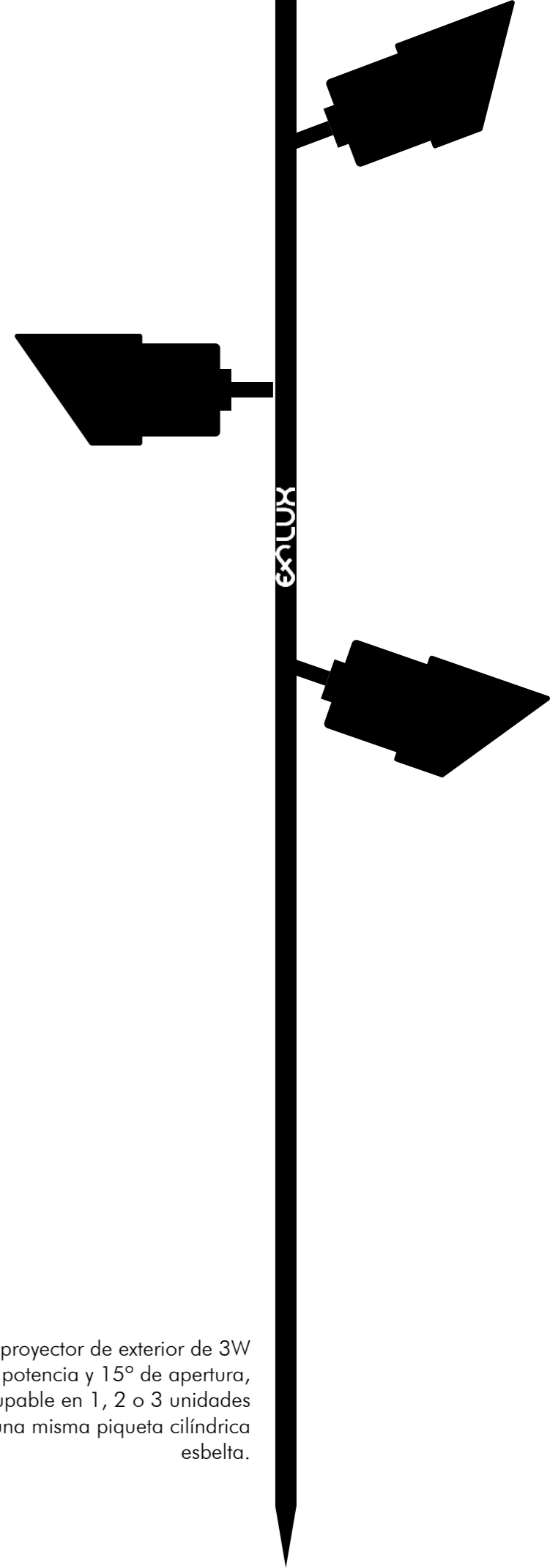

(52)

Material

Aluminio anodizado 5051

Acabados



Montaje



Temperatura de color



Protección / CRI / Certificados



(53)



Dimensiones

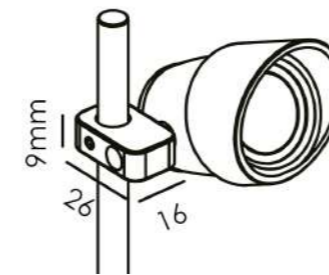

Parámetros

Potencia	3W por foco
Temperatura de color	2300 / 2700K
CRI	80 / 90
Ángulo de apertura	15°
Voltaje de entrada	AC220-240V 50-60Hz
Corriente de salida	700mA
Tensión de funcionamiento	4V
Flujo luminoso	198lm
Temperatura operativa	-25°C +40°C

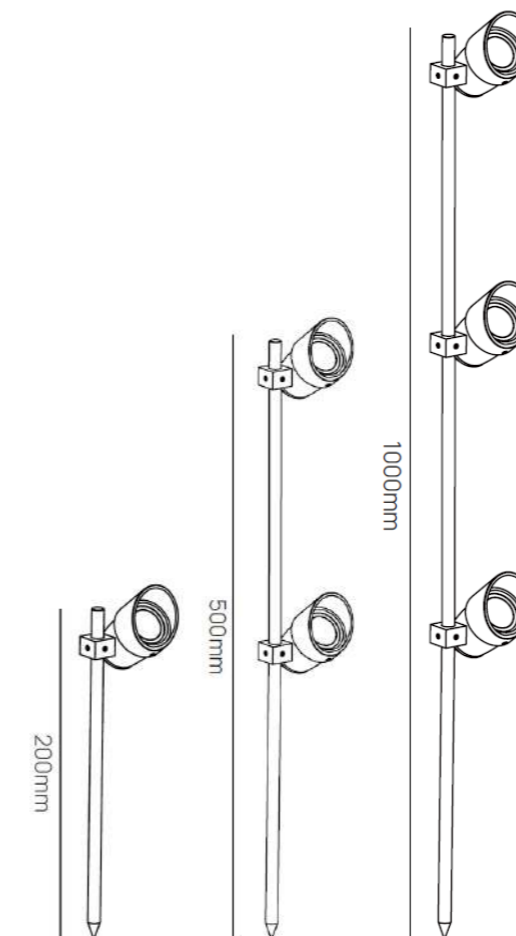

Referencias

MOMO S 1x3W

Negro			
2300K	15°	On/off	55610
	15°	Sin/Electrónica	55597
2700K	15°	On/off	55603
	15°	Sin/Electrónica	54149

MOMO M 2x3W

Negro			
2300K	15°	On/off	55627
	15°	Sin/Electrónica	55016
2700K	15°	On/off	55634
	15°	Sin/Electrónica	54156

MOMO L 3x3W

Negro			
2300K	15°	On/off	55665
	15°	Sin/Electrónica	55641
2700K	15°	On/off	55658
	15°	Sin/Electrónica	54163

Balizas de pared

(54)

enluxe (exterior) balizas de pared

Dit

Baliza exterior asimétrica empotrable de pared con fuente de luz de 3W de potencia y apertura en forma de grieta vertical. Produce un haz de luz en forma de línea estrecha nítida que se proyecta en el suelo.

Ideal para iluminación ornamental de acento en zonas de paso y escaleras.

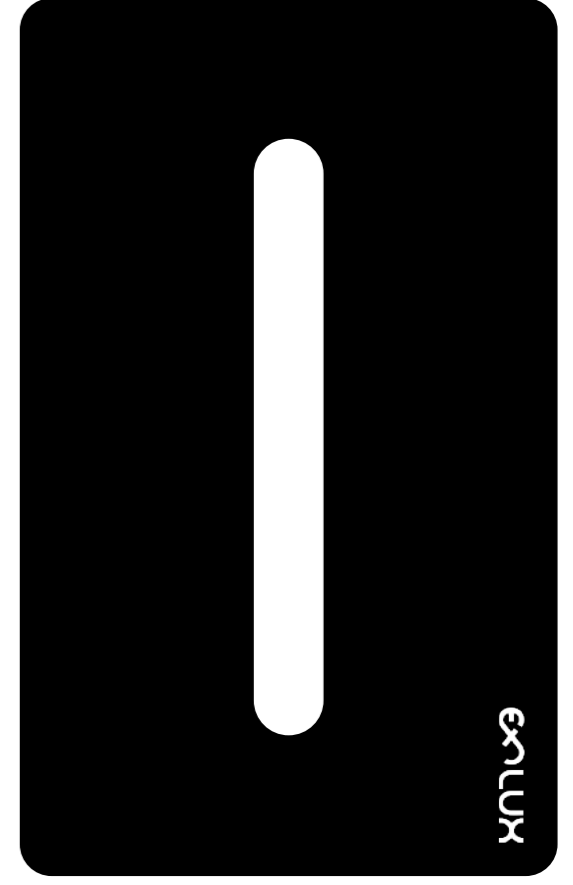

(56)

Material

Aluminio anodizado 5051

Acabados



Montaje



Temperatura de color



Protección / CRI / Certificados



(57)

Parámetros

Potencia	3W
Temperatura de color	2700K
CRI	80
Ángulo de apertura	15°
Voltaje de entrada	AC220-240V 50-60Hz
Flujo luminoso	80lm
Temperatura operativa	-25°C +40°C

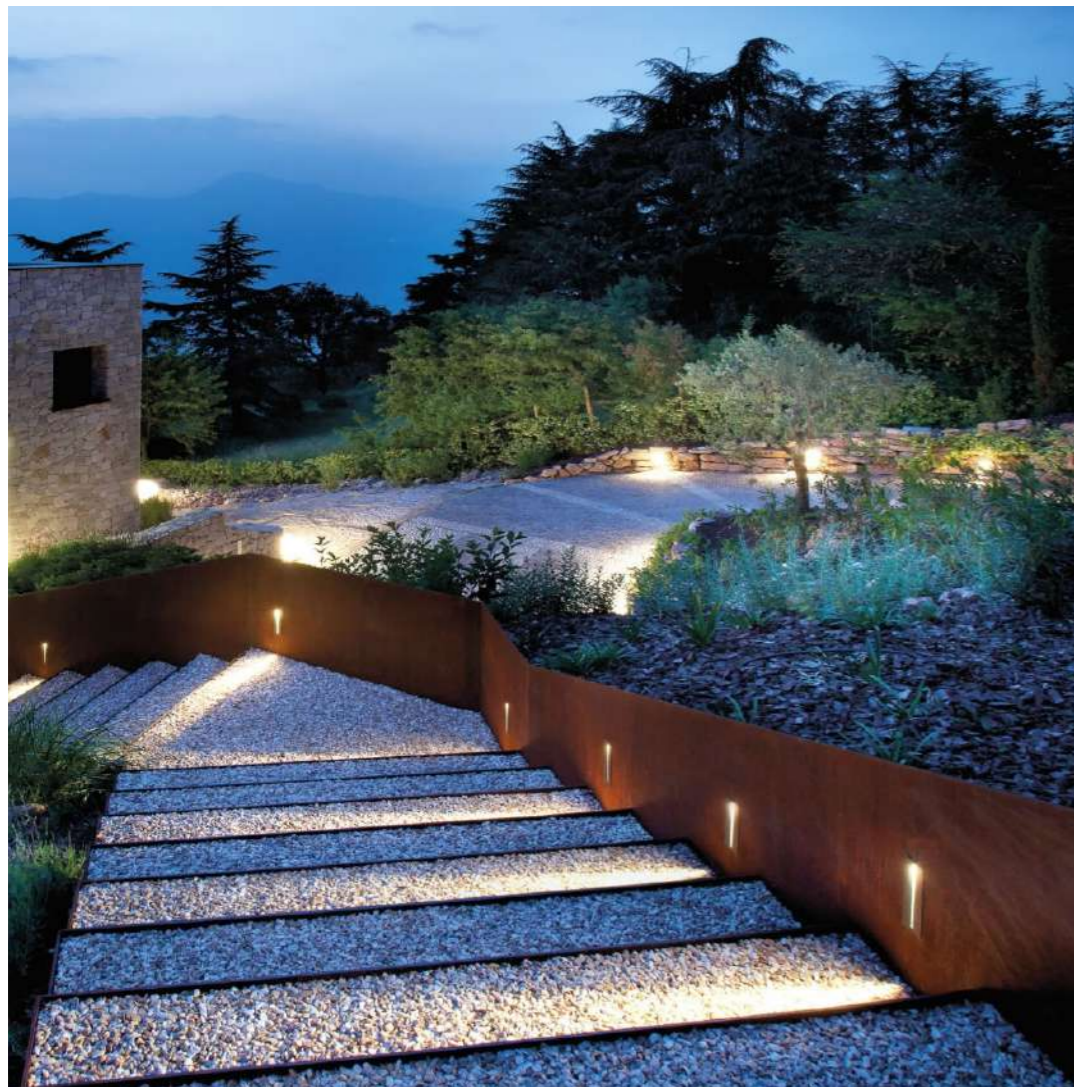

Referencias

DIT 3W

Negro			
2700K	15°	On/off	55160
	15°	Sin Electronica	55108

EXLUX (exterior) balizas de pared

Versot C

Baliza exterior asimétrica empotrable de pared con fuente de luz de 3W de potencia y 120° de apertura.

Su haz de luz va orientado hacia el suelo.

Ideal para la iluminación de zonas de paso y escaleras

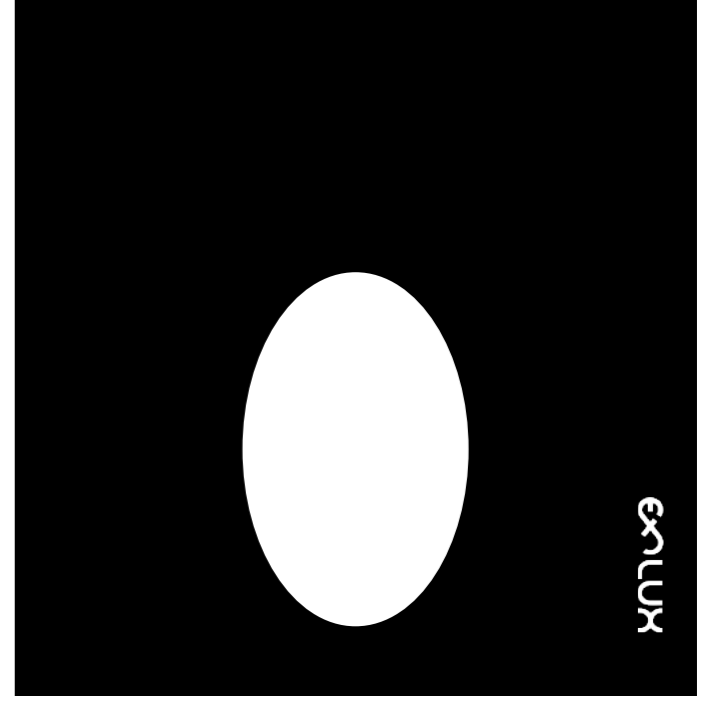

(60)

Material

Aluminio anodizado 5051

Acabados

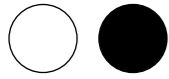

Montaje



Temperatura de color



Protección / CRI / Certificados

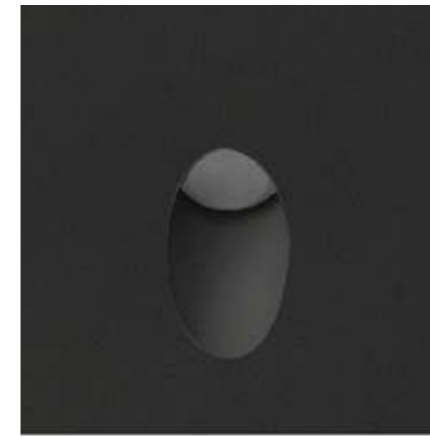

Dimensiones

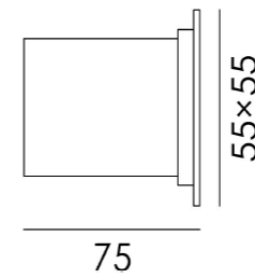

(61)

Parámetros

Potencia	3W
Temperatura de color	2700K
CRI	90
Ángulo de apertura	120°
Voltaje de entrada	AC220-240V 50-60Hz
Corriente de salida	700 mA
Tensión de funcionamiento	3V
Flujo luminoso	180lm
Temperatura operativa	-25°C +40°C

Referencias

VERSAT CUADRADO 3W

Blanco			
2700K	Asimétrico	On/off	53159
	Asimétrico	Sin Electrónica	58697
Negro			
2700K	Asimétrico	On/off	58673
	Asimétrico	Sin Electrónica	58680

EXLUX (exterior) balizas de pared

Versat R



Baliza exterior asimétrica empotrable de pared con fuente de luz de 3W de potencia y 120° de apertura.

Su haz de luz va orientado hacia el suelo.

Ideal para la iluminación de zonas de paso y escaleras

(64)

Material

Aluminio anodizado 5051

Acabados

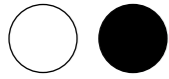

Montaje



Temperatura de color



Protección / CRI / Certificados



Dimensiones

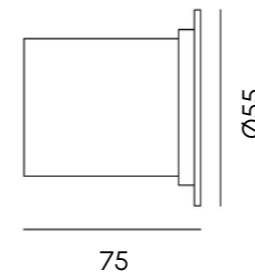

(65)

Parámetros

Potencia	3W
Temperatura de color	2700K
CRI	90
Ángulo de apertura	120°
Voltaje de entrada	AC220-240V 50-60Hz
Corriente de salida	700 mA
Tensión de funcionamiento	3V
Flujo luminoso	180lm
Temperatura operativa	-25°C +40°C

Referencias

VERSAT REDONDO 3W

Blanco			
2700K	Asimétrico	Triac	53166
	Asimétrico	Sin Electrónica	58703
Negro			
2700K	Asimétrico	Triac	57850
	Asimétrico	Sin Electrónica	58710

enluxe (exterior) balizas de pared

Verso

Baliza exterior asimétrica empotrable de pared con fuente de luz de 7W de potencia y 120° de apertura.

Su haz de luz va orientado hacia el suelo.

Ideal para la iluminación de zonas de paso y escaleras

(68)

Material

Aluminio anodizado 5051

Acabados



Montaje



Temperatura de color



Protección / CRI / Certificados



(69)



Dimensiones

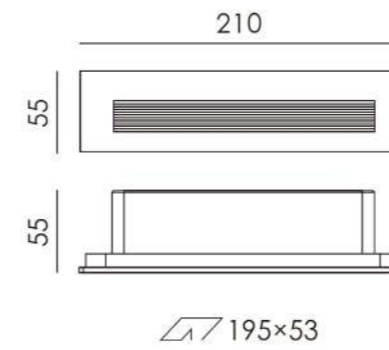

Parámetros

Potencia	7W
Temperatura de color	2700K
CRI	90
Ángulo de apertura	120°
Voltaje de entrada	AC220-240V 50-60Hz
Flujo luminoso	280lm
Temperatura operativa	-25°C +40°C

Bolardos

(70)

enluxe (exterior) balizas de pared

Alborys

Bolardo exterior en forma de prisma de 400mm de altura, 60 mm de ancho y 80 mm de profundidad con fuente de luz interna de 10W de potencia.

Su apertura en forma de grieta vertical le hace proporcionar un haz de luz lineal estrecho que se proyecta nítidamente en el suelo.

Ideal para iluminación ornamental de acento en zonas de paso.

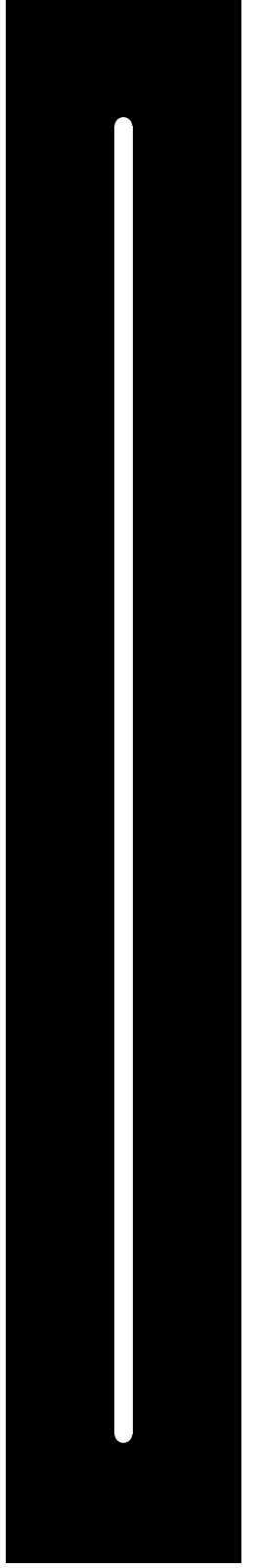

(72)

Material

Aluminio anodizado 5051

Acabados



Montaje



Temperatura de color



Protección / CRI / Certificados

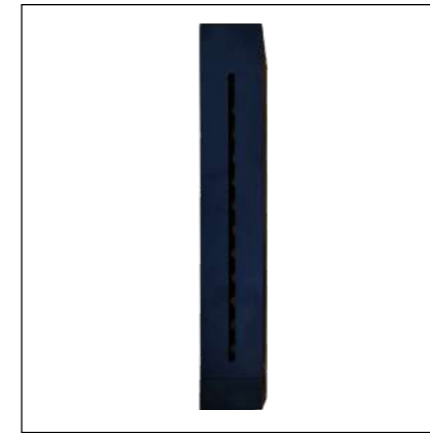

Dimensiones

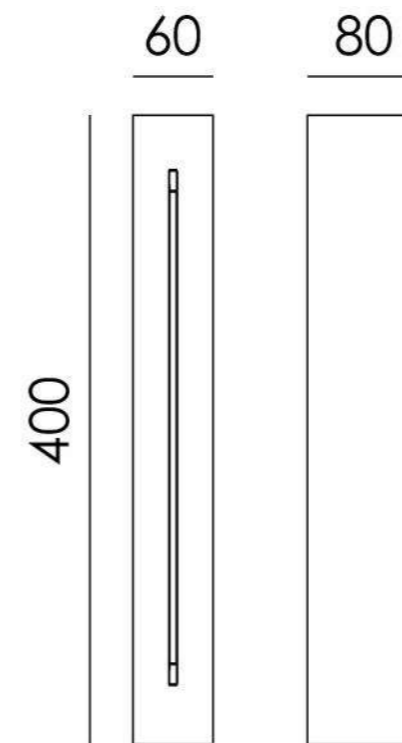

Parámetros

Potencia	10W
Temperatura de color	2700K
Chip LED	Osram
CRI	90
Ángulo de apertura	15°
Voltaje de entrada	AC 220-240V
Flujo luminoso	500lm
Temperatura operativa	-25°C +40°C



Referencias

ABYSS 10W

Negro			
2700K	15°	On/off	54286
	15°	Sin Electronica	55085

Wallwasher de superficie

(74)

enluxe (exterior) wallwasher de superficie

Bent

Wallwasher de exterior de estructura flexible que lo hace adaptable a curvaturas de un gran abanico de diámetros.

Ideal para iluminar pilares o superficies curvas, aportando una cantidad de luz uniforme en toda la superficie.

Disponible en temperaturas de color de 2300K y 2700K

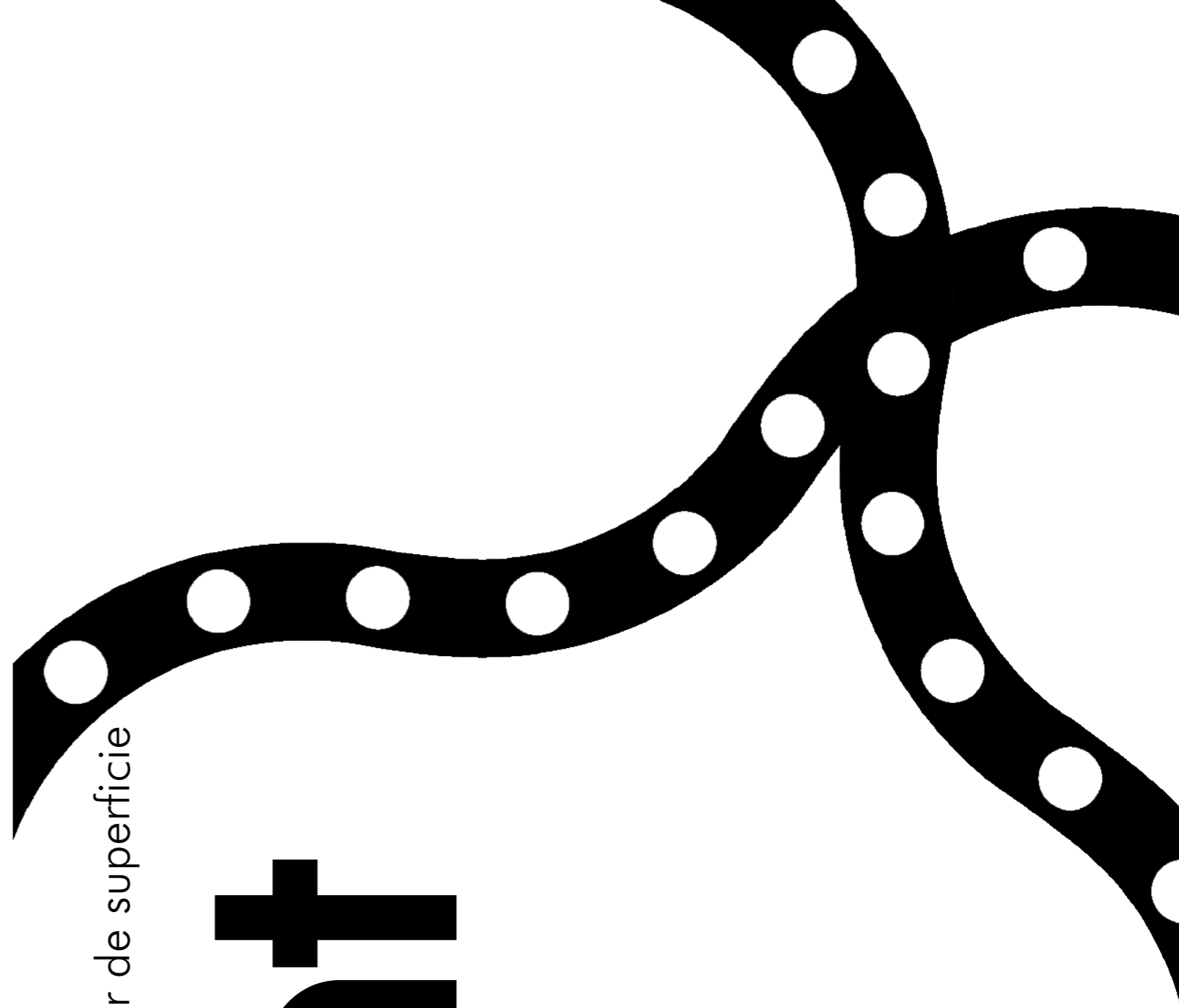

Material

Silicona

Acabados



Montaje



Temperatura de color



Protección / CRI / Certificados

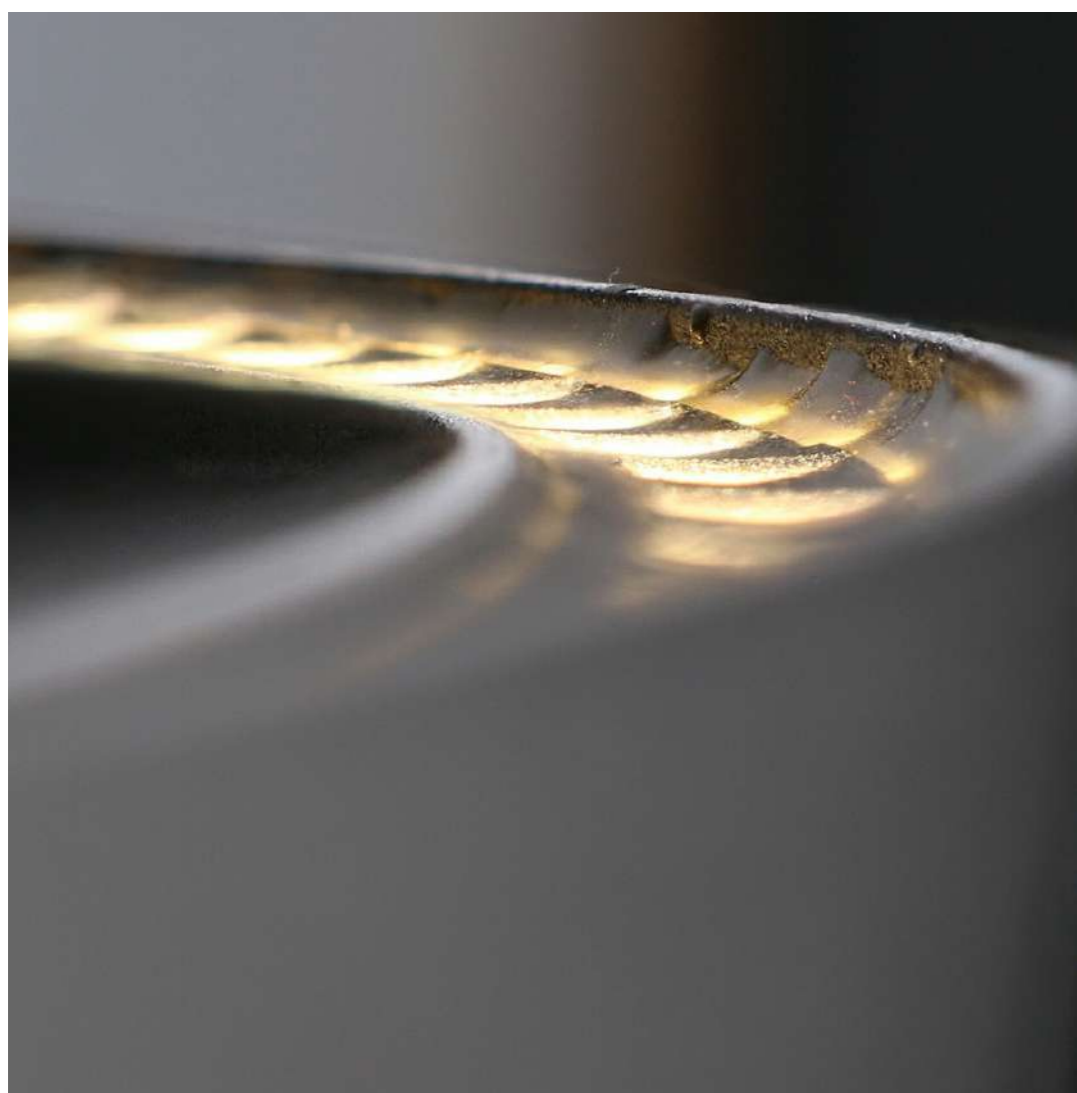

Parámetros

Potencia	24W/m
Temperatura de color	2700K
CRI	80
Ángulo de apertura	30°
Voltaje de entrada	24V
Temperatura operativa	-25°C +40°C

Referencias

Blanco			
2300K	30°	24V	58659
2700K	30°	24V	58864
Accesorios			
Perfil Aluminio 1 Metro			58841
Grapas			58888



EFLUX

La *luz*
en tus
manos.